

Instructions



AUDIO GUIDANCE SYSTEM SYSTEME AUDIO-GUIDE AUDIO-FÜHRUNGSANLAGE

XA-GP3BK/XA-GT1TN
XA-GC20BK

System Products

- Le système comprend
- Produkte in der Anlage
- XA-GP3BK Portable ROM Player
- XA-GP3BK Lecteur ROM portatif
- XA-GP3BK Tragbares ROM-Abspielgerät
- XA-GT1TN Infrared Address Transmitter
- XA-GT1TN Emetteur d'adresse infrarouge
- XA-GT1TN Infrarot-Adressensender
- XA-GC20BK Charger
- XA-GC20BK Chargeur
- XA-GC20BK Ladegerät

AUDIO GUIDANCE SYSTEM
SYSTEME AUDIO-GUIDE
AUDIO-FÜHRUNGSANLAGE

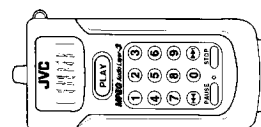

XA-GP3BK



XA-GT1TN

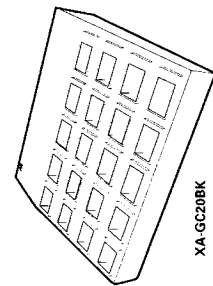

XA-GC20BK

INSTRUCTIONS MANUEL D'INSTRUCTIONS BEDIENUNGSANLEITUNG

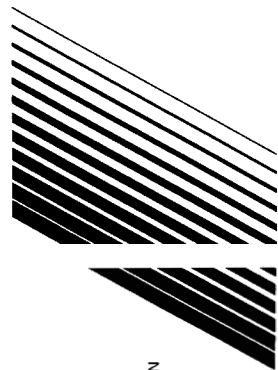

0601MMZQDSSAN

For Customer Use:
Enter below the Model No. and Serial No. which are located either on the rear, bottom or side of the cabinet. Retain this information for future reference.

Model No.
Serial No.

LVT0494-002A
[E]

Precautions for Safe Use

Precaution symbols

Various symbols are located in this manual as well as on the products. In order for this product to be used safely and correctly, symbols are provided to prevent any damage to the user, other people, or property. Therefore take the time to understand what the symbols mean before reading this manual.



DANGER
Failure to abide by the warnings that accompany this symbol will result in improper use of this product which may result in death or serious injury. Therefore this symbol and related instructions must be followed at all times.

Explanation of the Symbol

The symbols that alert you to points of caution.



General Caution



Electric Shock



DANGER

■ The internal battery pack was made to be used exclusively with the Portable ROM Player XA-GP3BK. Therefore do not use the battery pack for any use other than indicated may destroy, decrease performance, or shorten the life of the battery. Therefore do not use the batteries for devices for purposes other than indicated.

■ Only the XA-GC20BK Charger should be used to recharge the battery pack. Using any other charger than indicated may result in a fire hazard or device malfunctions.

■ Failure to observe the following in regard to the battery pack may result in a fire as well as cause overheating and damage to the unit.

- Do not put in a fire or apply any kind of heat source to the battery pack.
- Do not place, use, or recharge the battery pack where the temperature is high, such as near a fire or heater.
- Do not reverse the positive (+) and negative (-) polarity and attempt to use the battery.
- Also do not carry or store the battery pack with metal objects such as necklaces or hairpins.
- The positive (+) and negative (-) battery pack terminals should not come in contact with metal objects such as a needle.
- Do not puncture with a needle, strike with a hammer, or step on the battery pack.
- Do not attempt to solder, disassemble, or modify this product.



WARNING

Failure to abide by the warnings that accompany this symbol will result in improper use of this product which may result in death or serious injury.

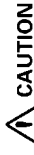

CAUTION

Failure to abide by the warnings that accompany this symbol will result in improper use of this product which may result in injury or property damage.

Symbols that indicate actions that are prohibited



Prohibited



Disassembling Prohibited

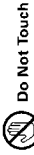

Do Not Touch

Symbols that advise you to perform a specific action



General Instruction



Pull Out the Plug

■ When the battery pack that is used in the XA-GP3BK has been removed, make sure to store it in a safe place out of the reach of children. Immediately seek the advice of a medical physician if the battery liquid is consumed.

■ Recharge the battery pack at a temperature between 5° - 35° C (41° - 95° F). Do not attempt to recharge the battery pack at a temperature below or above this range. Failure to recharge within this range may result in a decrease in performance, or shorten the life of the battery pack.

■ Using the unit when smoke, a strange smell, or an abnormal condition is detected may result in a fire hazard or electric shock.

 Immediately unplug the power cord from the outlet, confirm that smoke is no longer being produced, and have your dealer check or service the unit. The user attempting to service the unit is extremely dangerous and prohibited.

■ Do not use if there is dust or metallic objects attached to the power plug (or power adapter) blades. Failure to clean the plug blades may result in a fire hazard or electric shock.

■ Do not modify, force to bend, twist, or pull the power cord. This will damage the cord and may result in a fire hazard or electric shock.

■ Do not place heavy objects such as furniture on the power cord and take care not to allow the cord to become covered. Otherwise the power cord may be damaged and cause a fire hazard or electric shock.

■ If the cord does become damaged (the internal wires are exposed or the cord is cut), a replacement power cord may result in a fire hazard or electric shock.

■ When the unit is dropped or the cover is damaged, unplug the power cord from the power outlet and contact your dealer. Continuing to operate the product under these conditions may result in a fire hazard or electric shock.



■ Do not insert metal or combustible objects into the sockets that are present on the unit. Objects inserted into the unit may result in a fire hazard or electric shock.

■ Do not attempt to plug in or unplug the power cord with wet hands. Handling the power cord with wet hands may result in electric shock.

■ Do not touch the power cord during an electrical storm. Touching the power cord at this time may result in electric shock.



■ Take precautions to keep the unit dry and to prevent liquid from entering. In the event that liquid is spilled into the unit, unplug the power cord from the power outlet and contact your dealer. Continuing to operate the product under these conditions may result in a fire hazard or electric shock.



■ Use only power supplies with the indicated voltage. Failure to do so may result in a fire hazard or electric shock.

■ Do not attempt to modify this product in any way. Interfering with the internal mechanism may result in a fire hazard or electric shock.



CAUTIONS

■ The power cord should always be unplugged from the outlet by grasping the plug (or power adapter) and never the cord itself. Pulling on the cord itself will cause damage which may result in a fire hazard or electric shock.

■ The battery recharger's power cord should be located away from all heat sources. Melting of the cord coating may result in a fire hazard or electric shock.

■ Make sure to insert the plug (or power adapter) completely into the power outlet. Failure to plug in the power cord properly could cause a short circuit and produce heat that may lead to a fire hazard or electric shock. Also avoid using multiple connections where many plugs are connected to the same extension cord.

■ Do not use a power outlet that does not make a snug connection with the power cord plug (or power adapter). Loose and improper connections will give off heat and may result in a fire hazard. Contact a dealer or a certified electrician to have the defective power outlet replaced.

■ Do not place the unit in an excessively moist or dusty environment. Operating the recharger in such an environment may result in a fire hazard or electric shock.

■ Avoid placing the unit near a preparation area in kitchens or humidifiers. Exposing the unit to soot, humidity, or dust may result in a fire hazard or electric shock.

■ The unit should be installed on a level and stable surface. If the unit is used on an unstable surface, the unit may fall off, or the entire stand and unit may fall over causing bodily harm.

■ Confirm that the power cord plug has been removed from the outlet before attempting to move the unit. Moving the unit while plugged-in may damage the power cord and result in a fire hazard or electric shock.



■ Do not fold the power adaptor in cloth or bedding or wrap in any way. Covering or wrapping the adaptor will cause heat to build up, which may cause the case to change shape and result in a fire hazard. Therefore, always use the adaptor in an area that is well ventilated.

Handling Precautions

■ Handling precautions for the XA-GP3BK Portable Rom Player and the XA-GT1TN infrared Address Transmitter

This equipment is in conformity with the provisions and protection requirements of the corresponding European Directives. This equipment is designed for professional audio appliances and can be used in the following environments:

- Residential area (in houses) or rural area,
- Commercial and light industry; e.g. offices, theatres, museum or something similar,
- Urban outdoors

In order to keep the best performance and furthermore for electromagnetic compatibility, we recommend to use cables not exceeding the following length:

Port	Cable	Length	Port	Cable	Length
For XA-GP3BK HEADPHONE OUTPUT	Headphone Cable	2.0 metres	For XA-GT1TN DC SUPPLY INPUT	DC Power Cable	2.0 metres
			DATA INPUT	Shield Cable	2.5 metres
			DATA OUTPUT	Shield Cable	2.5 metres

Caution: Where there are strong electromagnetic waves or magnetism, for example near a radio or TV transmitter, transformer, motor, etc., the audio may be disturbed. In such a case, please keep the apparatus away from the sources of the disturbance.

■ **Install the XA-GC20BK Charger so that the back of the unit is more than 10 cm from a wall or other objects.**

Lack of air flow causes heat to accumulate and may cause a malfunction.

■ **Changing the fuse for the XA-GC20BK Charger**

The fuse for this product is 250V/5A (Amps).

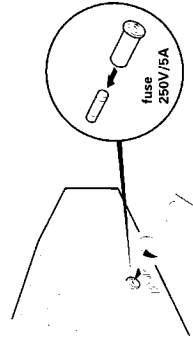

Flathead screwdriver

If the fuse blows soon after replacing, consult with the dealer where the audio guidance system was purchased. Under any circumstances do not use a fuse that is above the indicated amperage of "5A."



Spent rechargeable batteries are a valuable resource and should not be thrown away. Please take them to your local rechargeable battery recycling center.

Contents

Parts Names and Locations	2
How to Recharge the Portable ROM Player	3
How to Mount the Infrared Address Transmitter (XA-GT1TN)	4
How to Use the Portable ROM Player (XA-GP3BK)	12
Editing the CF Card	16
How to Operate the Portable ROM Player	18
Methods for Providing Information to Visitors	21
Maintenance	22
How to Change the Battery Pack	23
Troubleshooting	24
Specifications	26

Parts Names and Locations

For an explanation of each part, refer to the page number

Portable ROM Player (XA-GP3BK)

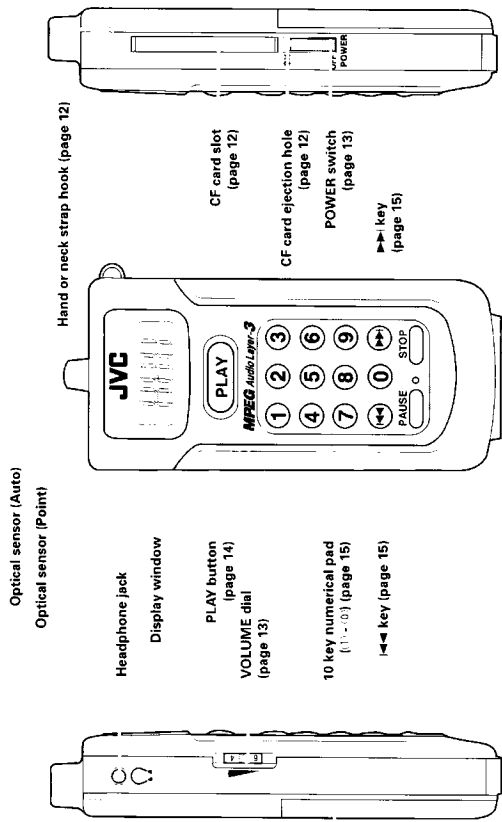

Infrared Address Transmitter (XA-GT1TN) : Transmitter

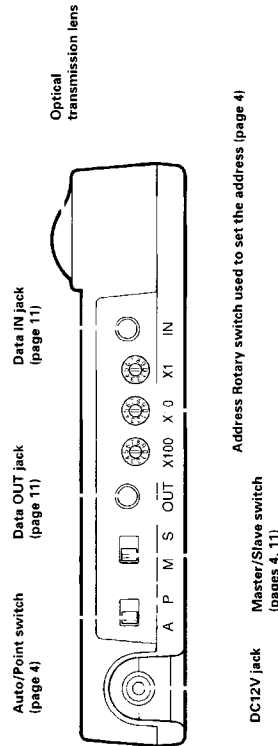

How to Recharge the Portable ROM Player

The Portable ROM Player operates on a battery pack which contains rechargeable Lithium ion batteries. Batteries should be recharged for more than three hours before use.

How to recharge the Portable ROM Player

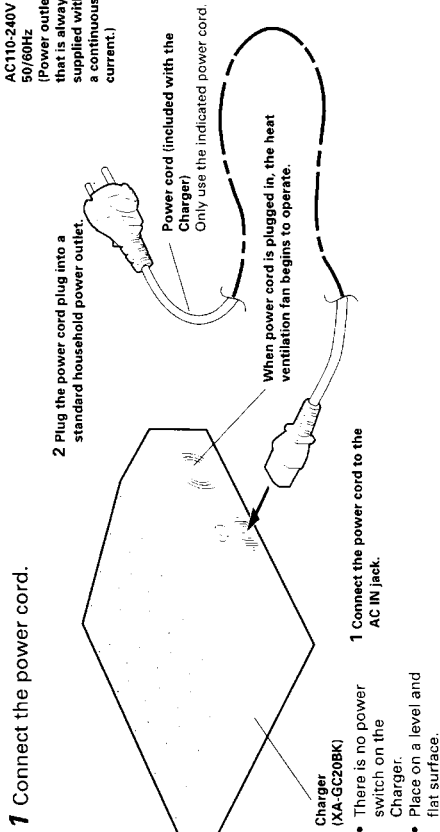

2 Insert the Portable ROM Player. The display window should be facing towards YOU.

- A maximum of 20 units can be recharged at one time.
The Portable ROM Player should be recharged with the POWER turned OFF. The amount of time necessary to recharge the batteries becomes slightly longer when the POWER is left ON.
- About 3 hours is required to fully recharge the batteries.
Even when the Portable ROM Player is left in the recharger, it is not possible for the batteries to become over charged.
- Recharge indicator
The battery level is indicated by the color of the light.

CHARGE	Red	: Less than 60% of recharging has taken place.
	Green	: The batteries are more than 60% recharged.

Note

- Take precautions to install the Charger more than 10 cm from a wall or other objects. This assures that the unit can be adequately cooled during operation.

How to Mount the Infrared Address Transmitter (XA-G1)

The Infrared Address Transmitter can be secured to either a cable or a ceiling railing.

Settings for each switch

1 Setting the address

- Set the desired address with the rotary switch. (000 - 255)

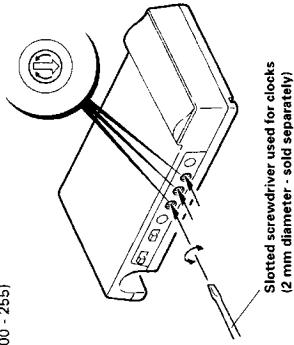

2 Setting the Auto/Point switch

- To enter the Auto Start mode
 - Set the switch to "A"
 - Auto.
- To enter the Pointing mode
 - Set the switch to "P"
 - Point

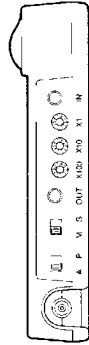

3 Setting the Master/Slave switch

- The switch is now set to "M" master.

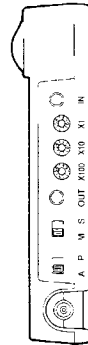

Regarding connections to the power source

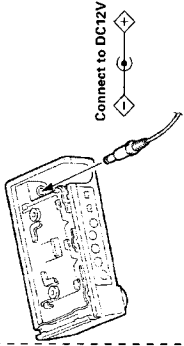

<Notice>

- When the transmitter is placed in a high position, ensure it is installed correctly to prevent it from falling and causing injury or damage.

Attaching the cable clamps (securing the unit to a cable)

- For more information on mounting a ceiling railing, refer to page 8.

1 Remove the screw and separate parts A and B.

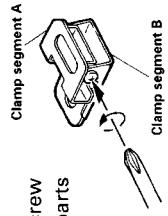

2 Secure parts B and C to the cable with the screws.

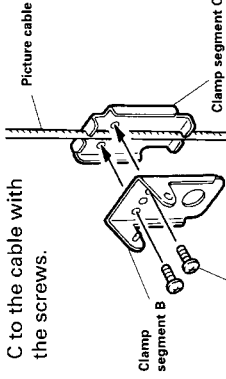

3 Insert metal fixture A and secure with the screw.

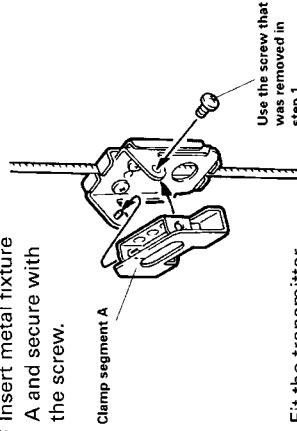

4 Fit the transmitter onto the secured mount.

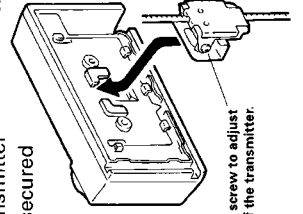

How to Mount the Infrared Address Transmitter

(continued from page 5)

An example of the "Pointing" method.

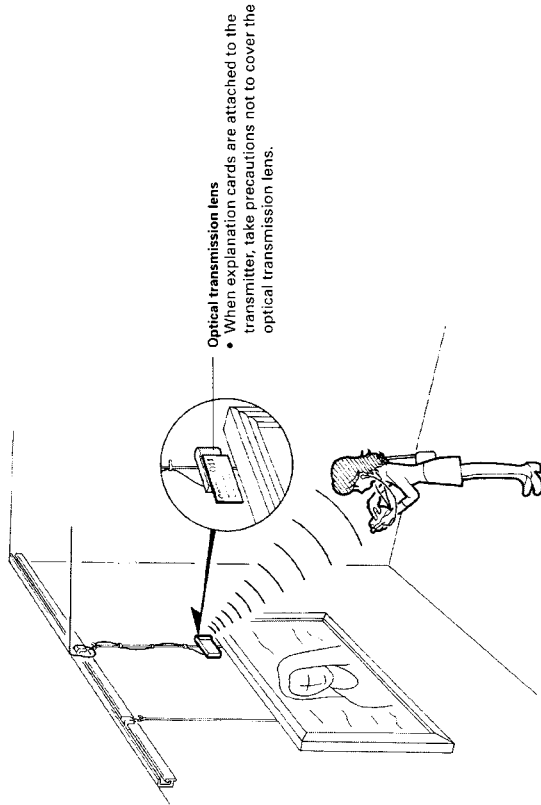

■ Installation position

- Position the transmitter close to the picture that will be explained.
 - For large size pictures, it is recommended that the visitor be adequately informed as to where the Portable ROM Player should be pointed.
- Example : Instructions for the visitor, such as "Please Point the Portable ROM Player at the name of the picture and press (PLAY)" can be printed on a card and placed on the transmitter.

■ Adjusting the Angle of the Transmitter

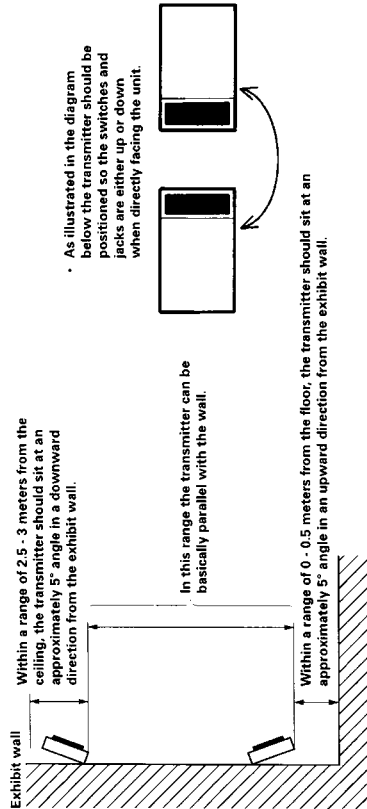

■ Selecting a Transmitter

With the transmitters set up with 2 meter intervals between them, even at a distance of 5 meters, a transmitter can be easily selected.

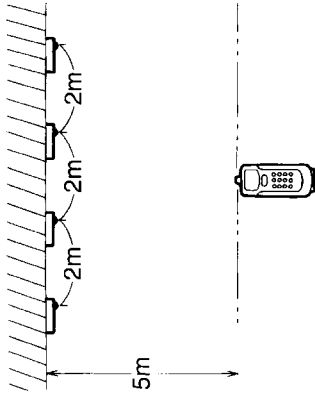

■ Transmission Distance

Directly facing the transmitter at a distance of 7 meters (When installed in a room, the transmitter should not be exposed to direct sunlight.)

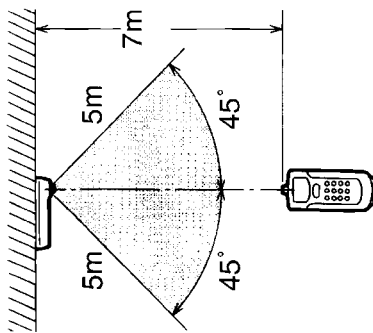

■ Transmission Area

When facing the transmitter, signals are sent within a 45° angle from a central axis. "Play" will be easily activated at a distance of 5 meters from the transmitter.

■ Range characteristics of the transmitter

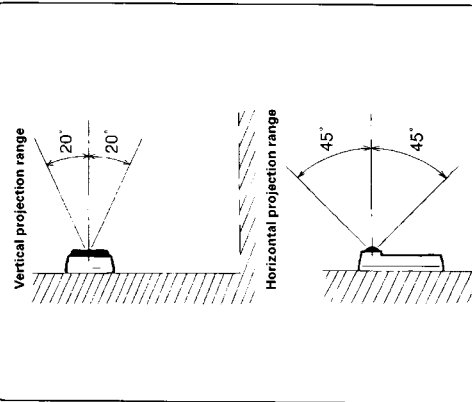

■ Optical sensor characteristics for the Portable ROM Player

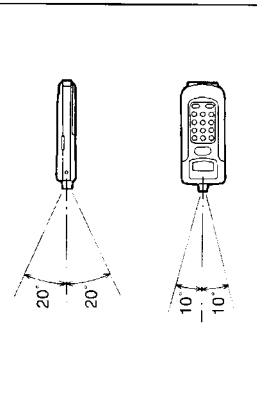

How to Mount the Infrared Address Transmitter

(continued from page 7)

An example of "Auto Start" method

- The transmitter should be installed for example at the entrance to the exhibit, in the path of the visitor.

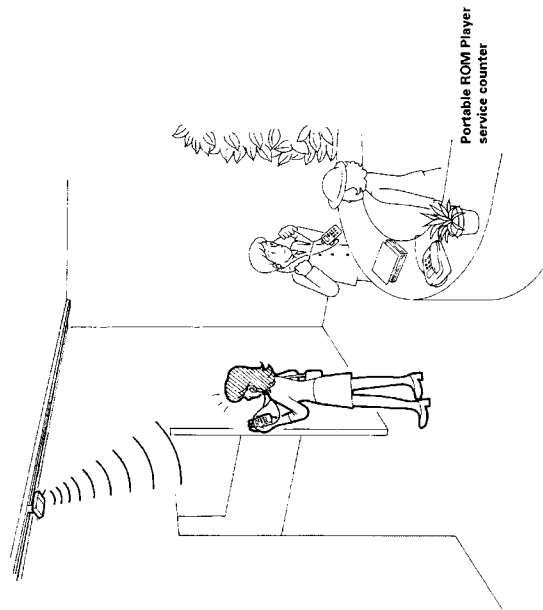

Installation position

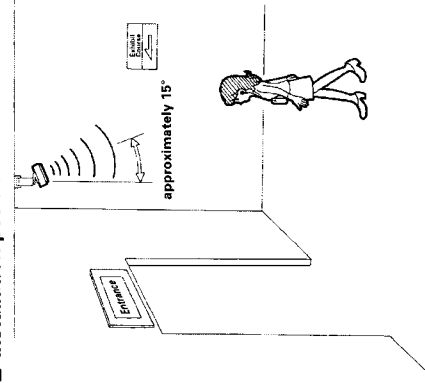

- Install the transmitter in a place where the visitors will pass and will be facing in one direction.
- The transmitter should be positioned along the exhibit course at about a 15° angle in the opposite direction in which the visitors move.

Note
It is possible that under certain conditions, the Auto Start method will fail to operate. Therefore it is not advisable to use this system to inform the visitor of emergency exits or any other life-saving information that is necessary during an emergency.

Transmission Distance

Directly below the transmitter at a distance of 5 meters (When installed in a room, the transmitter should not be exposed to direct sunlight.)

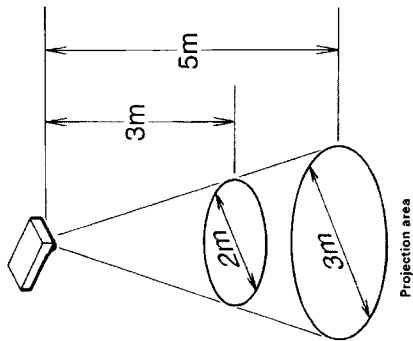

Note

When an "Auto" signal is received during "Point" playback, the Portable ROM Player will automatically switch to the "Auto" playback. For this reason, provide as much space as possible between the Point and Auto transmitters.

Range characteristics of the transmitter

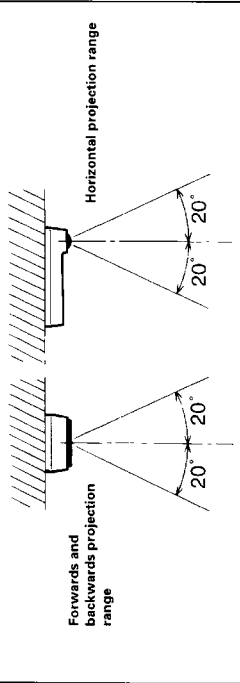

Optical sensor characteristics for the Portable ROM Player

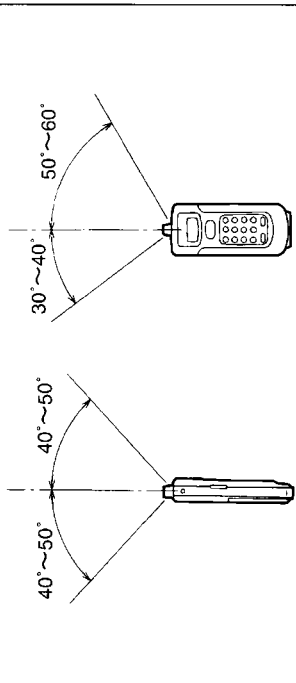

How to Mount the Infrared Address Transmitter

(continued from page 9)

When transmitting the same address data to a larger area, multiple XA-GT1TN can be connected to operate together.

Connecting multiple Infrared Address Transmitters

• An example of the "Pointing Method"

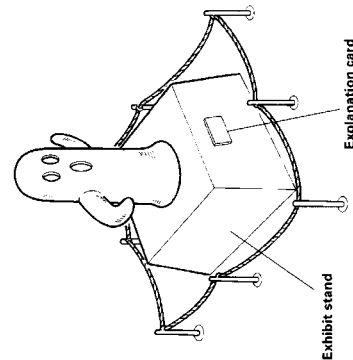

- When displaying a three-dimensional exhibit and a wider area needs to be covered by the Audio Guidance System, multiple XA-GT1TN Infrared Address Transmitters can be connected to operate together. To accomplish this setup, one transmitter is set as the "master" and the other transmitters are set as "slaves." All of the address data that is set for the master will be transmitted from all of the slaves as well.
- As seen in the exhibit illustrated in the diagram, only one visitor facing the work of art can receive the playback information. However, by connecting four XA-GT1TN transmitters in a master/slave relationship, the visitor can listen to the playback at different points surrounding the exhibit.
- Each transmitter's Auto/Point switch, should be set to "P" point.



- Connect the power adaptor to each transmitter.
- A maximum of five XA-GT1TN units can be connected.

- In the diagram below, data is transmitted from a "master" transmitter to the linked "slave" transmitters in sequence. The procedure for setting up this type of master/slave connection is described on the following page.

XA-GT1TN transmitter acting as a slave.

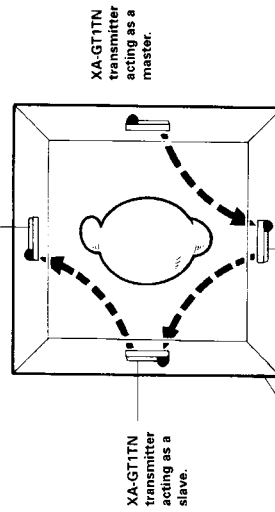
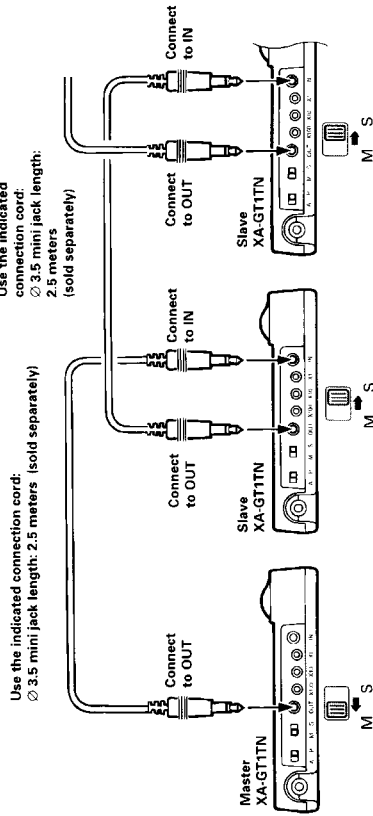

Exhibit stand

XA-GT1TN transmitter acting as a slave.
(Aerial view of the exhibit)

• How to Make Connections



This transmitter's Master/Slave switch is set to "M" master.

The second transmitter's Master/Slave switch and all others (up to the fifth transmitter) is set to "S" slave.

< Notice >

- The power source must be connected for every transmitter.
- Setting the Auto Start method for multiple transmitters: While referring to the above explanation "How to Make Connections," connect the transmitters accordingly. In this setup, the Auto/Point switch is set to "A."



This enables the Audio System to provide information to a larger area.

How to Use the Portable ROM Player (XA-GP3BK)

To prevent any accidents such as dropping the Portable ROM Player, it is recommended that the included hand or neck strap be attached before use.

Attaching the hand or neck strap

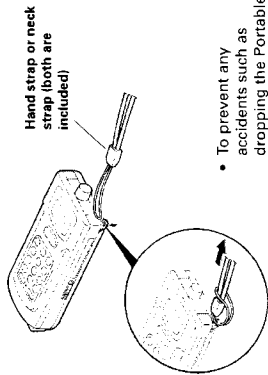

- To prevent any accidents such as dropping the Portable ROM Player, please attach the hand or neck strap.

Adjusting the length of the neck strap

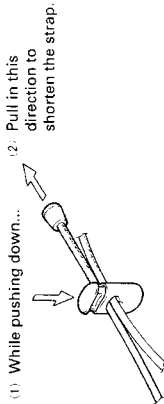

- While pushing down...
- Pull in this direction to shorten the strap.

Inserting and ejecting the CF card

- Inserting the card

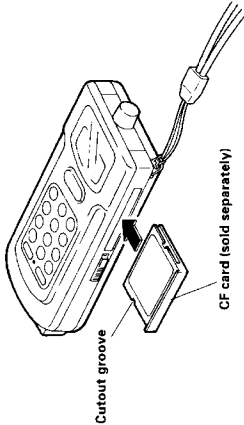

- With the surface that has a cutout groove facing up, insert the card into the slot. (The card cannot be inserted upside down.)

- Ejecting the card

- Turn the POWER to OFF.
- Push a screwdriver (2 mm diameter) into the CF card ejection hole.

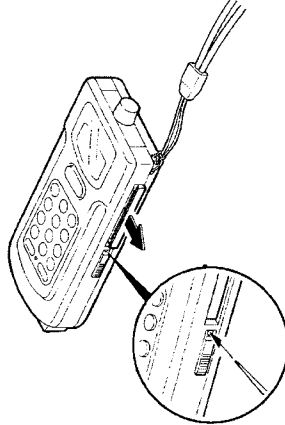

- Slotted screwdriver used for watches
Push a screwdriver (2 mm diameter) or similar tool into the hole and the CF card will come out.

Using the headphones

- Insert the headphones (sold separately) mini plug into the headphone jack located on the Portable ROM Player.

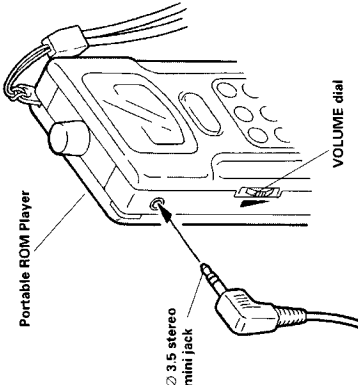

- Adjust the volume to a comfortable level.

- Sound is still produced even if the VOLUME dial is set to "MIN" minimum.
- The audio of a monaural file is also reproduced from both left and right channels.
- When a monaural earphone is used in playing a stereo audio file, the audio is output only from the left channel.

Caution on the volume level

If you listen to playback for long hours at a very high volume level, your sense of audio may be damaged. Also, if the volume control is set to a high volume level before starting playback, sudden reproduction of loud audio may also damage your ears.

English

How to turn on the power

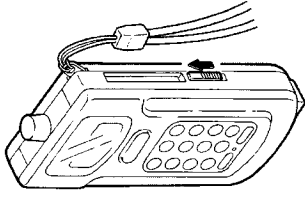

- Set the POWER switch to ON.

The initialization screen appears in the display window. After about 5 seconds, the unit enters stand by.

- Initialization**
When the power is turned on, the following screens appear in the display window:



- When the CF card is absent, "mCF" (no CF) is displayed and operation stops here.

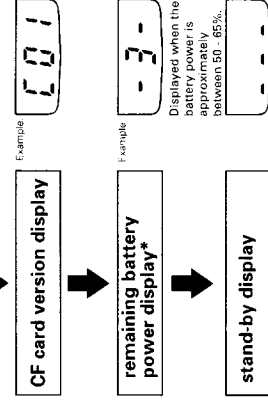

- At this point, the unit is in stand by.
- The remaining battery power display will differ according to the power remaining in the rechargeable batteries.

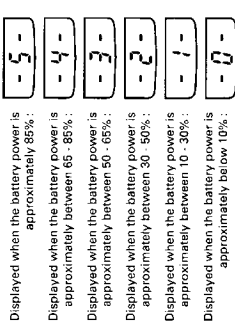

-Notice-

- The remaining battery power indication is variable depending on the operating conditions (temperature, etc.). Use the indicated data simply as a reference.

English

How to Use the Portable ROM Player (continued from page 13)

Playback starts through reception of encoded infrared signals or by inputting commands with the numerical keys.

Playback through the reception of encoded infrared signals

There are two types of playback available: "Point reception" which operates in close proximity to the exhibited work of art, and "Auto reception" which operates automatically when the Portable ROM Player enters an area of reception.

- Starting playback through Point reception. (Pointing method)

- 1 Point the extended pointer on top of the Portable ROM Player at the Infrared Address Transmitter.
 - For information on the signal transmission distance, refer to Transmission Area on page 17.

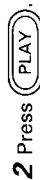

- The encoded infrared signals are received and when a "Point message" is present, playback will start. When playback does not start, move closer to the Infrared Address Transmitter and push **PAUSE** once more.

- If the set is in the middle of playback, first press the **STOP** button to stop playback then press **PLAY**.



- To let playback pause temporarily:



- Press the **PAUSE** button. The button lamp blinks and playback pauses. Playback can be resumed by pressing the **PAUSE** button again or **PLAY**.

<Notice>

- If the volume is adjusted during use, noise may be generated. This noise is generated due to step-by-step variation of the volume level and not a malfunction.

Playback is possible even when an Infrared Address Transmitter has not been installed.

Playback with the 10 numerical keys

Playback is possible by entering an address number directly.

- Playback can also be controlled with the 10 numerical keys.

- 1 Input the address number using the 10 numerical keys.

- Input the desired number to input the three-digit number. Example: To input the address number "001," press key (1).



The entered number blinks.

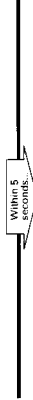

- 2 Press **PLAY**. Playback begins.



The entered number stays lit.

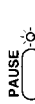

Lights

Note:

- If an address number is entered, playback begin.
- To stop playback at any time during the message, press the **STOP** button. To listen to the message once more, repeat steps 1 and 2.

- When an address number is entered that does not exist, the unit returns to stand by and (---) is displayed.

- When **PLAY** is not pressed within 5 seconds of selecting an address number, the unit returns to stand by (---). To reenter the desired address number, start from step 1.

- Playback with **STOP**, **PAUSE** keys.

- 1 Press the **STOP** or **PAUSE** key to display the desired address number.

Example: When you want to listen to address number 003.

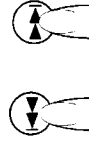

The address number blinks.

Each time this key is pressed, the unit moves to the next number. Each time this key is pressed, the unit moves to the previous number.



- 2 Press **PLAY**. Playback begins.

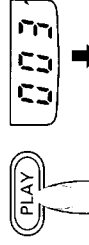

The selected number stays lit.

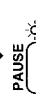

Lights

- To stop playback at any time during the message, press the **STOP** button. To listen to the message once more, repeat steps 1 and 2.

- When the **STOP** or **PAUSE** is pressed, numbers that have not been assigned an address will be skipped. This allows you to do a "search" for the next assigned message each time you press the key.

- When **PLAY** is not pressed within 5 seconds of selecting an address number, the unit returns to stand by (---). To reenter the desired address number, start from step 1.

Editing the CF Card

Root directory

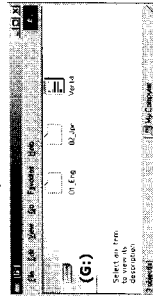

Format of the CF card

- The CF card uses the DOS format. The compatibility with long file names is not provided.
- Store message files in subdirectories [01??????] on the root directory. The part of [01] can be a number between 01 and 30. (The default is 01.) The part of [???....] can be specified as desired.

Message groups (Multi lingual function)

Message selection can be made easier by grouping each message file according to the language and other attributes and storing each group of message in one of subdirectories [01???.] to [30???.]. For how to select the subdirectory to be played, see "Message group selection" on page 18.)

Naming message files

Assign each file name as shown below.

Point reception file
P001????MP3 (or .WAV)

Auto reception file
A101????MP3 (or .WAV)

- "P" in the head indicates that the message is to be played by selected playback of point reception. "A" in the head indicates the message is an auto message.
- The 2nd to 4th characters indicate an address number, which can be between 000 and 970. With the selected or auto playback based on IR code reception, the range is between 000 and 255. In other words, 256 to 970 can be used only with messages which can be played by a key entry. These file names should be started with "P" at the head.
- Do not assign the same address number to a message for point reception and that for auto reception.
- The 5th to 8th characters can be assigned as desired.
- Be sure to use extension .MP3 or .WAV.
- This function is limited to playback of WAV files in compliance with MP3.

Sub-directory (when folder 01-Eng is selected)

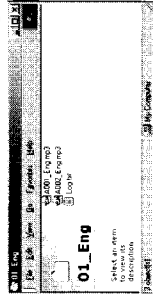

- **<Notice>**
 - Be sure to use a CF card provided by JVC.
 - At JVC, we introduce you experts in the CF Card authoring staff. Please do not hesitate to consult us.
- **Recording of message**
 - When recording every message, leave a mute section of about 300 ms after the end of message. Otherwise, the message may stop before the end.

CF card version display file

When the version display file is placed on the CF card's root directory, the CF card version can be displayed after the display of the software version at the moment the power is turned ON. This function allows you to identify the contents of the CF card. The version display is not displayed if the file is not present in the CF card.

- **File name**
 - The version display file should be named VER.TXT.

File format

The format of the version display file is as shown below. The version number (00 to 99) will be written in the head of the file.
Be sure to use 1-byte half-width characters in the version number.

- **Display**
 - The CF card version is displayed as a number such as [C01]. The part of [01] is variable depending on the version number written in the version display file.

Log Text

The playback start and stop counts of messages can be logged. If you keep a file named LOG.TXT in the subdirectory where messages are played, the numbers of times playback of each message started and stopped can be recorded in a LOG.TXT file. The contents of the LOG.TXT files can be checked from the PC and shown on the display of the XA-GP3BK.

The display format of LOG.TXT consists of the message number, and 10 spaces for additional input possibility. (Every line requires a total of 16 characters.)

```
No.000      ↓  
No.001      ↓  
No.002      ↓  
No.003      ↓  
No.004      ↓  
      *  
      *  
      *  
No.969      ↓  
No.970      ↓
```

Lines for No. 000 to 970 should be prepared regardless of the number of messages in the subdirectory.

How to Operate the Portable ROM Player (continued from page 19)

Toggle playback upon reception of identical auto IR code

When the CF card contains message files [A255] and [A989] and when [255] is specified during reception of auto IR code, this function plays message [255] at the first reception but plays message [989] at the second reception of the identical IR code, and automatically alternates the playback of the two files every time the IR code is received. This function is convenient for example in the welcome and farewell messages in case the inlet and exit are common. (Message [A255] is always played at the first reception of the code.)

Even during playback of [A989], the message number shown on the display is [255].

Resetting toggle playback upon reception of identical auto IR code

In the standby mode (in which --- is displayed):

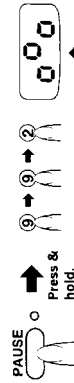

Toggle playback upon reception of identical auto IR code can be reset as shown above.

- After resetting, it is message [A255] which will play the next time the IR code for [255] is received.

<Notice>
The above is not displayed when the CF card does not contain message files [A255] and [A989].

Auto special message playback

This function is convenient for example in notifying the closing time or assembly appointed time. When the set time period (see the next column) has elapsed, message file A993777.MP3 (or .WAV) is played automatically.

During playback of the message, the reception of the key entry and auto IR codes is disabled.

Setting auto playback time of special message

The time of notification of closing time of an establishment or appointed time for assembly can be set in minutes.

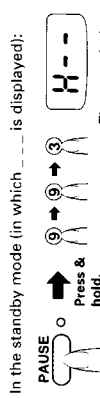

The auto playback time setting mode starts and waits for the setting of time.



The set time blinks, then the set returns to the standby mode.

- If auto playback time has already been set: "H..." and the remaining time till the start of auto playback (minutes) are displayed alternately. The previously set time can be changed by pressing numeric keys to overwrite previous data then pressing **[PLAY]**.

To abort the time setting in the middle, press the **STOP** button. This returns the set to the standby mode.

<Notice>
This function cannot be enabled unless message [A993] is contained in the card.

Remaining battery power indication

In the standby mode (in which --- is displayed):

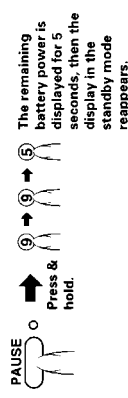

- The remaining battery power is displayed in the same way as when the power is turned ON. (See page 13.)
- When the **STOP** button is pressed in the middle of remaining battery power display, the set returns to the standby mode.

Methods for Providing Information to Visitors

Points to remember when the visitor receives the Portable ROM Player

- Turn the **POWER** to ON and confirm the following points when handing the Portable ROM Player to the visitor.

1 Check the remaining battery power.

- The visitor should receive the unit when more than **[- 3 -]** is displayed.
(If there is less power than indicated above, "No Battery Power" may occur during the exhibit.)

2 Check the CF card.

- Confirm that the CF card is what the visitor requested and that the card has been inserted. Also check the card version in the display window.

3 Check the headphone.

- Confirm that sound is properly produced from the headphone. The recommended volume is between 4 and 6.
- < Notice >**
It is recommended that headphones are replaced regularly. Especially after extended periods of use, the wire at the base of the plug often becomes cut. Therefore make sure that the headphones are properly working.
- Headphones should always be cleaned and replaced regularly in order to maintain public standards of personal hygiene.

- When a child is using the Portable ROM Player, to prevent accidents, replace the neck strap with the hand strap.

Points to remember when the visitor returns the Portable ROM Player

- Confirm the following points when the visitor has finished viewing the exhibit and returns the Portable ROM Player.

1 It is recommended that the following is said to the visitor when the Portable ROM Player is returned;

"Thank you very much for visiting our exhibit today. We hope you had no difficulties with the Portable ROM Player!"

- In the event that the visitor did have some problems, leave the CF card inserted, hand the Player to the Audio Guidance System administrator, and explain the problem.

Example: The visitor was not able to hear the explanation for exhibit number XX in exhibit hall number XX.

2 Check that the CF card is still inserted.

- In the event that the card is missing, immediately request that the visitor return the card.

3 Turn POWER to OFF.

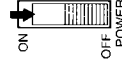

- This will extend the life of the batteries. It is recommended that the batteries are returned to the recharger for recharging.

Maintenance

How to Change the Battery Pack

Although the life of the battery pack will vary according to the amount of use, the average is about 2 years. When the battery pack can only supply power for an extremely short period of time even after recharging, the pack should be replaced. The battery pack should be discarded and replaced with a new one.

Cleaning the rechargeable battery terminals

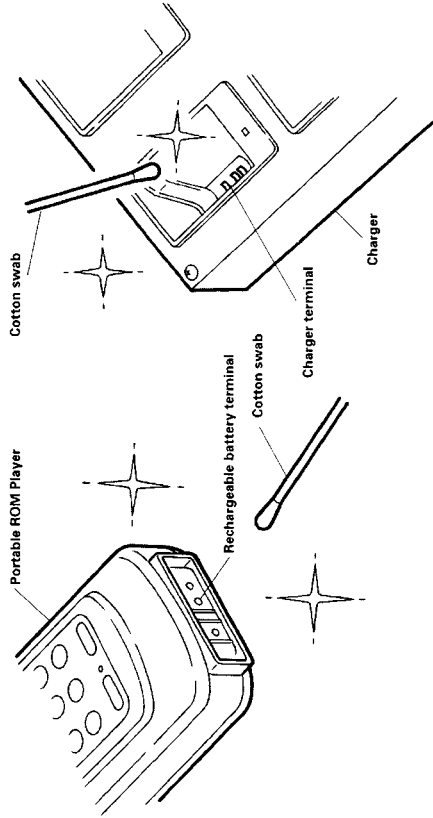

- The terminals should be cleaned about once a month. If the terminals are not cleaned regularly, it is possible that debris will hinder recharging.
- The Portable ROM Player should only be cleaned with a dry and soft cloth. Make sure that the optical sensor lens is kept completely clean.

English

How to change the battery pack

- 1 Open the battery cover on back of the Portable ROM Player.
- 2 Take out the battery pack.

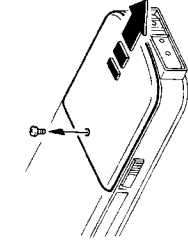

- The battery pack (BN-R372) is sold separately.

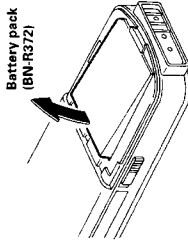

- 3 Replace the old battery pack with a new one and put back the cover.

Insert the battery with the inscription facing upwards.

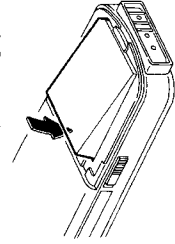

- The battery pack specified for the Portable ROM Player is the BN-R372. It is designed exclusively for use with the XA-GP3BK Portable ROM Player.
- Close the cover and recharge the new battery pack for more than 3 hours.







Spent rechargeable batteries are a valuable resource and should not be thrown away. Please take them to your local rechargeable battery recycling center.

English

Troubleshooting

Problem? Malfunction?
If problems arise, first try these suggestions before having the unit serviced.

English

Problem	Possible cause	Solution	Reference page
Checking the Portable ROM Player	<ul style="list-style-type: none"> POWER is not turned ON. 	<ul style="list-style-type: none"> Turn POWER switch to ON. 	page 13
	<ul style="list-style-type: none"> When POWER is turned ON, the display window stays fixed on the display  	<ul style="list-style-type: none"> There is a problem with the internal program of the main unit. Contact a JVC service representative. 	•
	<ul style="list-style-type: none"> The internal battery pack has not been recharged. 	<ul style="list-style-type: none"> Recharge the Portable ROM Player with the recommended charger. 	page 3
Checking the Portable ROM Player	<ul style="list-style-type: none"> The battery pack is about 2 years old and should be replaced. 	<ul style="list-style-type: none"> Purchase a new battery pack (BN-R372) at your local dealer. 	page 23
	<ul style="list-style-type: none"> POWER is not turned ON. 	<ul style="list-style-type: none"> Plug the power adaptor into a power outlet. 	page 4
Checking the Infrared Address Transmitter	<ul style="list-style-type: none"> Master/Slave switch is not switched to "M" master. 	<ul style="list-style-type: none"> Switch to "M" master.  	page 4
	<ul style="list-style-type: none"> Auto/Point switch is not set properly. 	<ul style="list-style-type: none"> When using the Pointing method:  set the switch to "P" point. 	page 4
	<ul style="list-style-type: none"> Does not operate. 	<ul style="list-style-type: none"> When using the Auto method:  set the switch to "A" Auto. 	page 4
	<ul style="list-style-type: none"> Address number is not properly set. 	<ul style="list-style-type: none"> Set the correct 3 digit address number using the Address Rotary switch. 	page 4
<ul style="list-style-type: none"> The exhibit card is covering the optical transmission lens. 		<ul style="list-style-type: none"> Place the card so that the optical transmission lens is visible. 	page 6

English

Problem	Possible cause	Solution	Reference page
Checking the Infrared Address Transmitter	<ul style="list-style-type: none"> Optical transmission lens on the transmitter or the sensor lens on the Portable ROM Player is dirty. 	<ul style="list-style-type: none"> Clean the optical transmitter or the sensor lens on the Portable ROM Player. 	•
	<ul style="list-style-type: none"> The infrared beam projection range is extremely short. 	<ul style="list-style-type: none"> Place a blind to cover the region of the window where the sunlight enters. 	•
	<ul style="list-style-type: none"> Transmission area is too small. 	<ul style="list-style-type: none"> Place the transmitter away from that type of fluorescent light. Or replace the light with a more common type of fluorescent light. 	•
Checking the CF card	<ul style="list-style-type: none"> Installation angle of the transmitter has slipped or was not set properly. 	<ul style="list-style-type: none"> Install the transmitter correctly after referring to the examples that illustrate the Pointing method and the Auto method. 	page 6 — page 9
	<ul style="list-style-type: none"> Does not operate. 	<ul style="list-style-type: none"> The set address and the CF card file do not match. Wrong CF card was inserted. 	page 4
Charger	<ul style="list-style-type: none"> Power cord is not plugged in properly. 	<ul style="list-style-type: none"> Plug the power cord completely into the outlet. 	page 3
	<ul style="list-style-type: none"> Cannot recharge the Portable ROM Player. 	<ul style="list-style-type: none"> Clean both terminals used for recharging. 	page 22
	<ul style="list-style-type: none"> Fuse has blown. 	<ul style="list-style-type: none"> Replace the fuse with a new one. (Use 250V/5A fuse.) 	page G-3

Note

- JVC is not responsible for any lost revenues or damages incurred due to the improper operation or malfunctioning of these products. This should be fully understood in advance before attempting to use these products.
- Many of the functions of the Portable ROM Player are executed with the use of micro processors. In the event that the unit does not operate properly due to for example static electricity, turn the POWER to OFF. Then after a short while, turn back to ON.

Specifications

In order to improve products, the specifications below and the external design are subject to change without notice.

Portable ROM Player (XA-GP3BK)

Recording medium Flash memory card (CF card)
 Sampling frequency 48 kHz/24 kHz/12 kHz,
 44.1 kHz/22.05 kHz/11.025 kHz, 32 kHz/16 kHz/8 kHz

Audio compression algorithm MPEG Audio Layer-3

Bit rate 8 kbps to 192 kbps

Playback time Approx. 2 minutes per 1 MB (with 64 kbps)

Explanation start method Pointing, auto start, numeric key input, skip

Max. numbers of messages 971 (using memory card)

Power supply DC 3.7 V (uses rechargeable Lithium ion batteries BN-R372)

Battery power duration Approx. 10 hours for continuous play
 Approx. 24 hours for intermittent play*
 (* Assuming 30% of total operation time is active playback)

Output jack Headphones (stereo mini, \varnothing 3.5)

Power output Approx. 9 mW + 9 mW/32 Ω

Dimensions 58.6 (W) x 141.4 (H) x 23.5 (D) mm

Mass Approx. 165 g (with battery pack)

Provided Accessories

- Hand strap x 1
- Neck strap x 1

Charger (XA-GC20BK)

Maximum number of units that can be recharged 20 (XA-GP3BK)

Recharging time Approx. 3 hrs. (when fully recharged)

Power consumption 270 VA (when charged)

Power supply AC 110-240 V, 50/60 Hz

Dimensions 477 (W) x 138 (H) x 438 (D) mm

Mass Approx. 7.5 kg

Provided Accessories

- Power cord x 1

Infrared Address Transmitter (XA-GT1TN)

Transmission method JVC Infrared Encoding Address Transmitter

Address settings Mini rotary switch x 3 (Code No. 000 ~ 255)

Directional angle Horizontal direction:
 Approx. $\pm 20^\circ$ (when set to Auto)
 Approx. $\pm 45^\circ$ (when set to Point)
 Vertical direction:
 Approx. $\pm 20^\circ$

Transmission distance Approx. 7 m (depending on hall conditions)

Power source DC 12V $\pm 10\%$, more than 0.1 A (stabilized power) (using the specified power adapter)

Dimensions 120.5 (W) x 28 (H) x 66 (D) mm

Mass Approx. 110 g

Provided Accessories

- Metal fixture mount x 1
- Screw (M3 x 6 mm) x 2

Additional Accessories (sold separately)

- Memory card (CF card)
- Headphones
- Rechargeable Lithium ion battery : BN-R372
- Master/Slave connection cord (\varnothing 3.5 mini plug included) length 2.5 m.